

**Agenzia del Territorio**  
**CATASTO FABBRICATI**  
**Ufficio Provinciale di**  
**Messina**

Dichiarazione protocollo n. _____ del _____	
Planimetria di u.i.u. in Comune di Messina	
Via Interna Mortelle. _____ civ. _____	
Identificativi Catastali:	Compilata da:
Sezione:	Irrera Nunzio
Foglio: 47	Iscritto all'albo:
Particella: 498	Architetti
Subalterno:	Prov. Messina N. 596

Scheda n. 3      Scala 1:100

**piano terra**

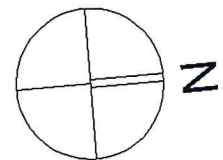
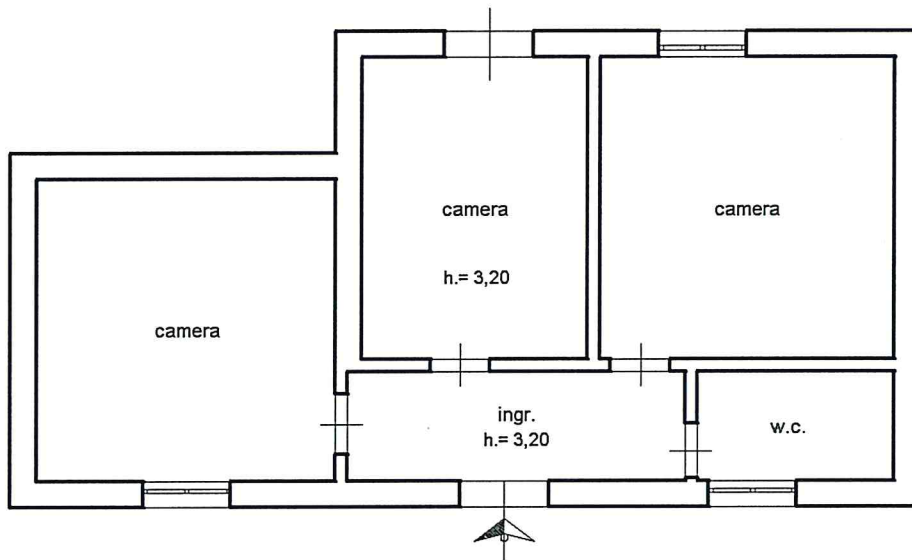

**Agenzia del Territorio  
CATASTO FABBRICATI  
Ufficio Provinciale di  
Messina**

Dichiarazione protocollo n. \_\_\_\_\_ del \_\_\_\_\_  
Planimetria di u.i.u. in Comune di Messina  
Via Interna Mortelle. \_\_\_\_\_ civ. \_\_\_\_\_

**Identificativi Catastali:**

Sezione:  
Foglio: 47  
Particella: 661  
Subalterno:

Compilata da:  
Irrera Nunzio

Iscritto all'albo:  
Architetti

Prov. Messina

N. 596

Scheda n. 1      Scala 1:100

piano terra

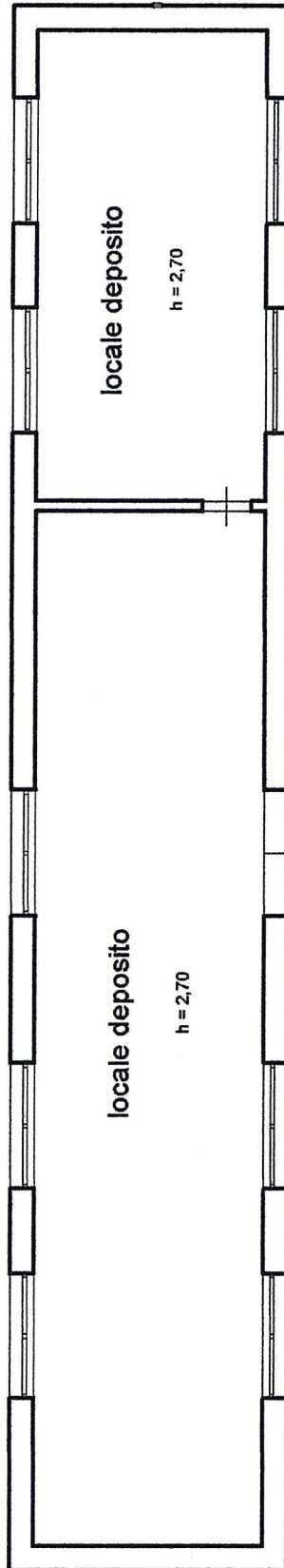

Dichiarazione protocollo n. _____ del _____ Planimetria di u.i.u. in Comune di Messina Via Interna Mortelle. _____ civ. _____	
Identificativi Catastali: Sezione: Foglio: 47 Particella: 659 Subalterno:	Compilata da: Irrera Nunzio Iscritto all'albo: Architetti Prov. Messina N. 596

Scheda n. 1      Scala 1:100

# PIANO TERRA

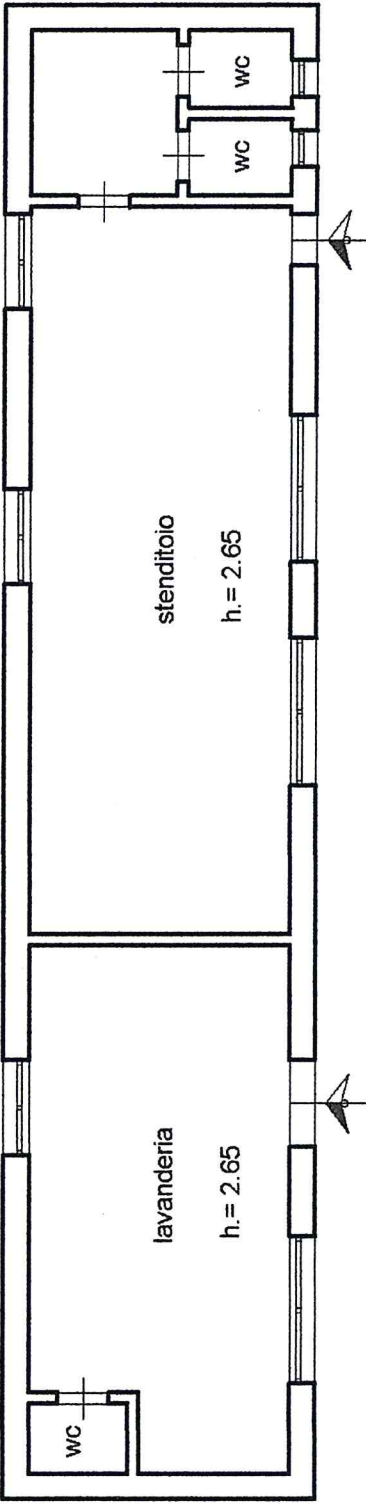

1:100

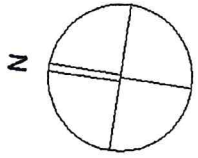

piano terra

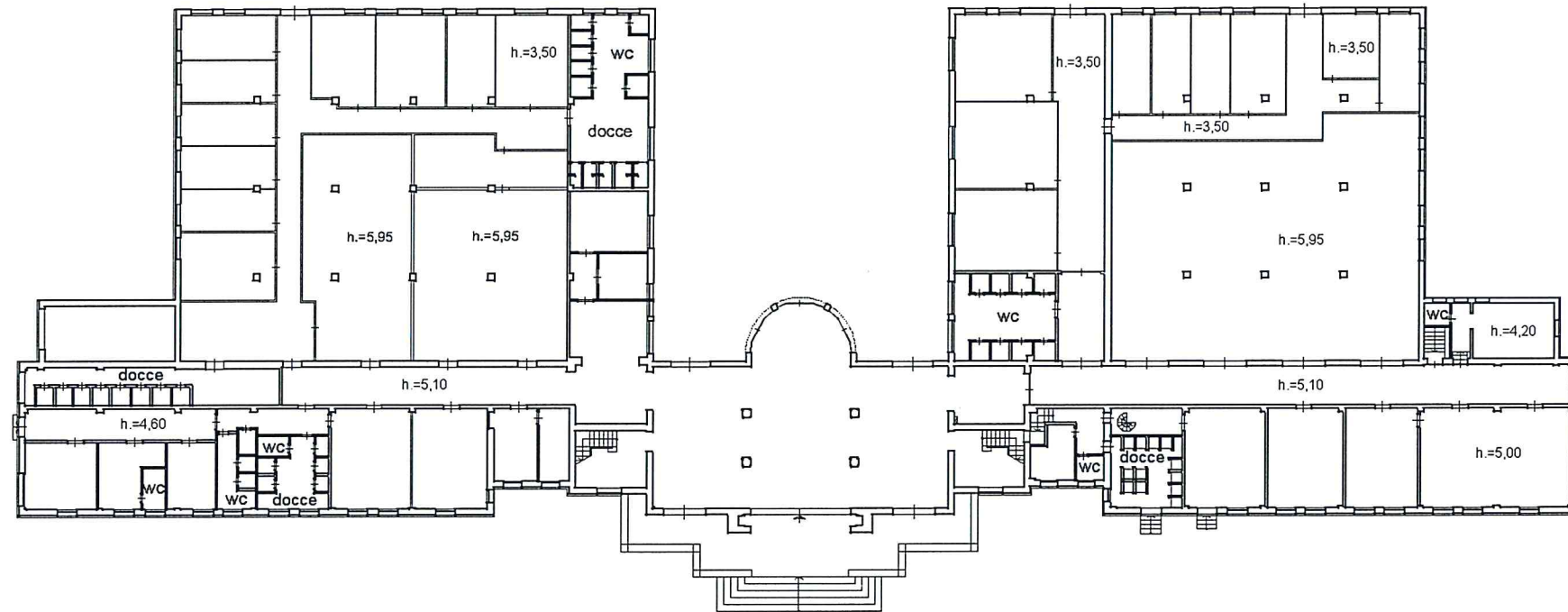

piano S/1

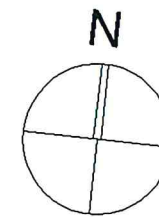
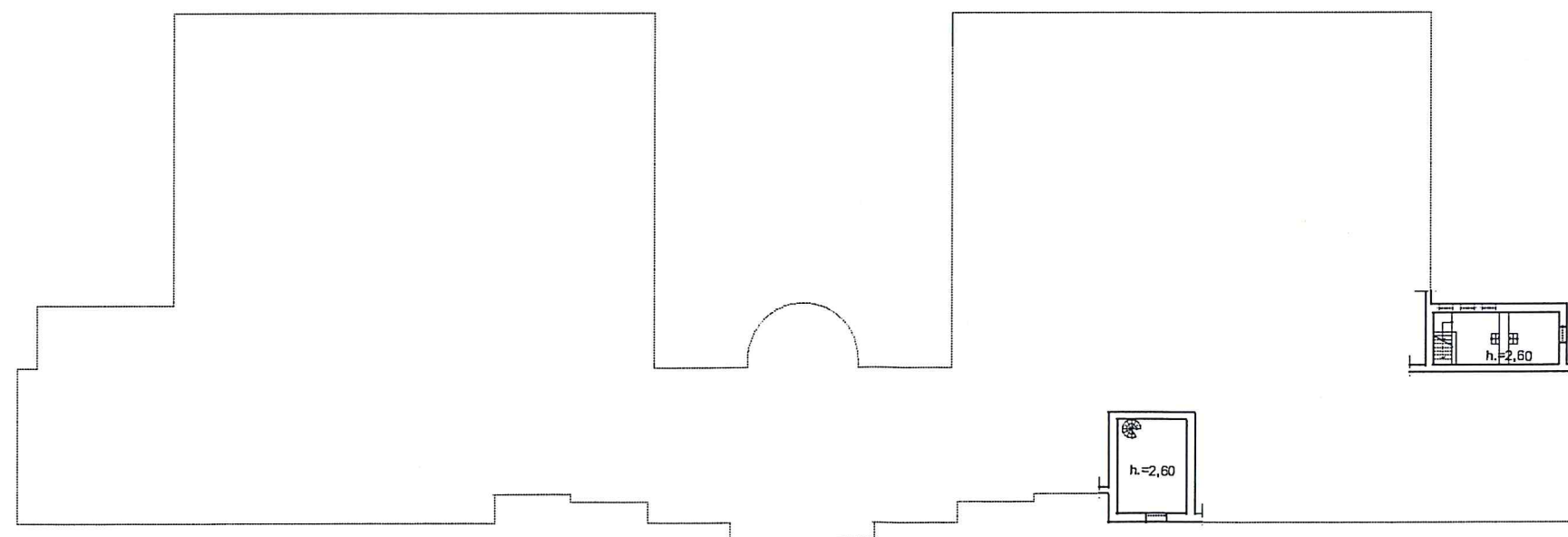

piano secondo

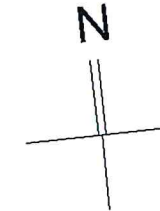
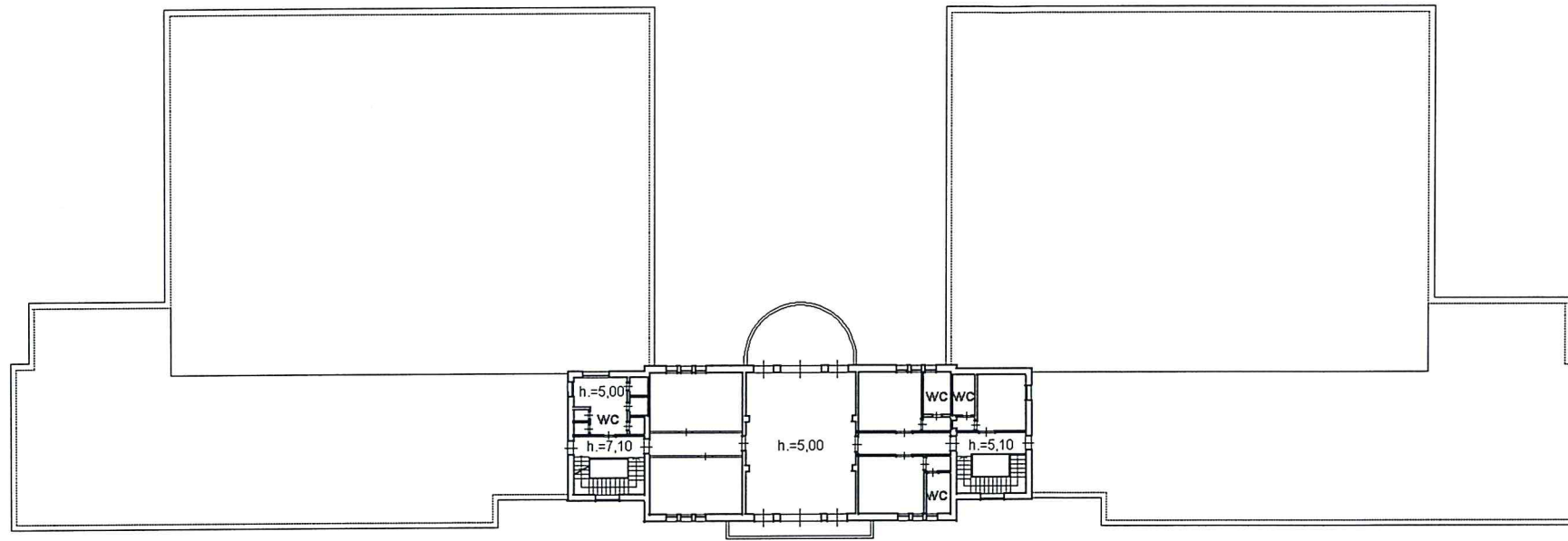

piano terzo

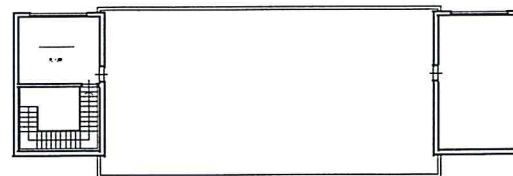



piano terra 1:200

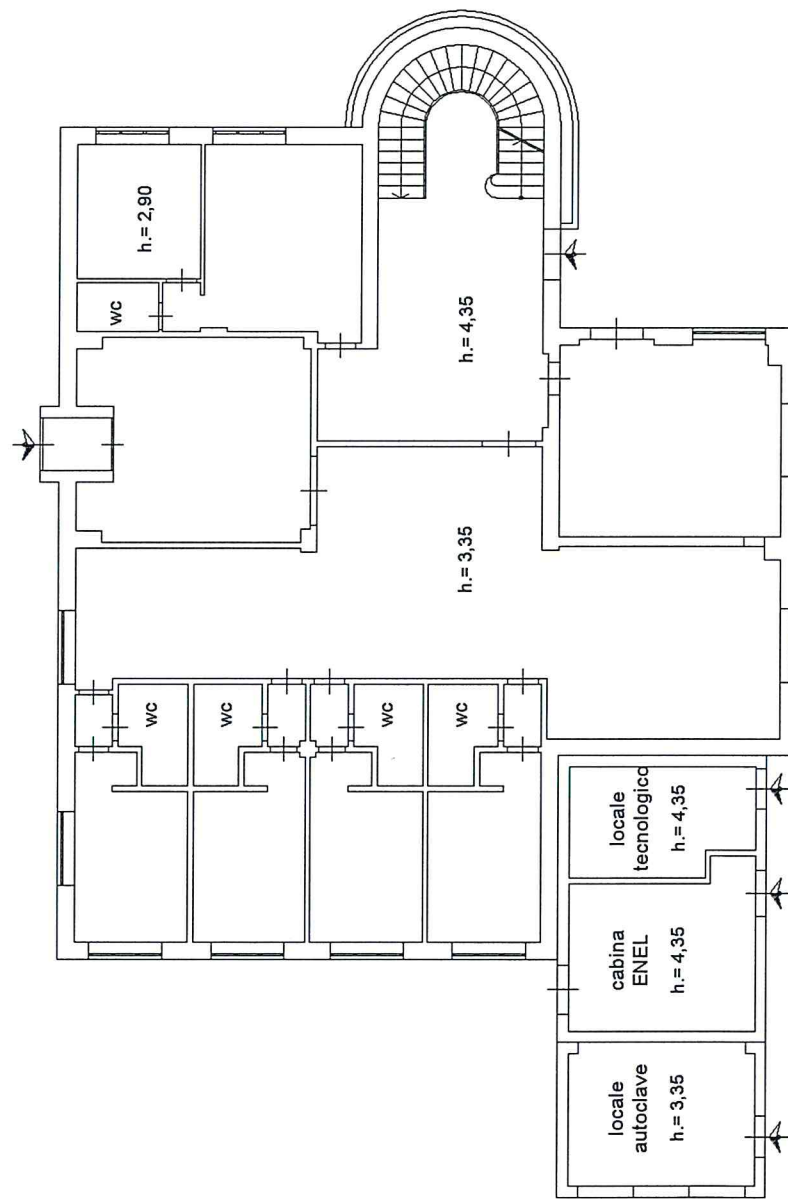

piano primo 1:200

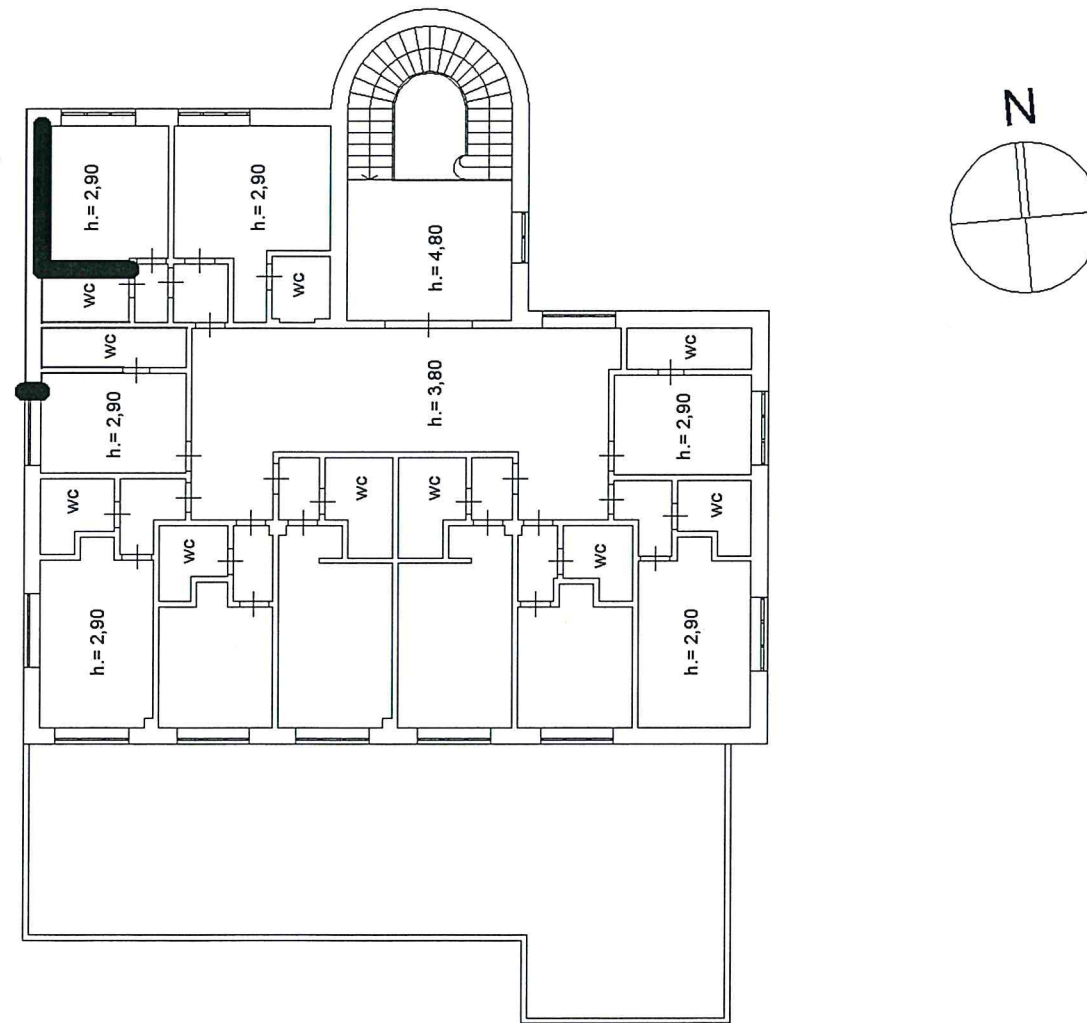

piano terra

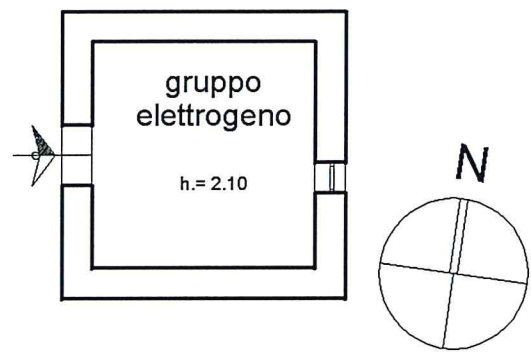

piano terra

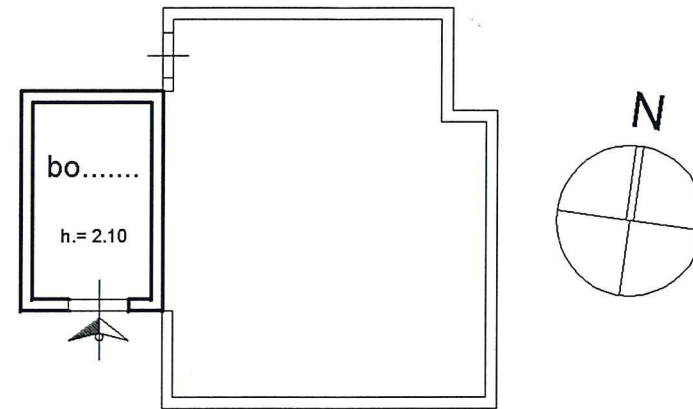

piano terra

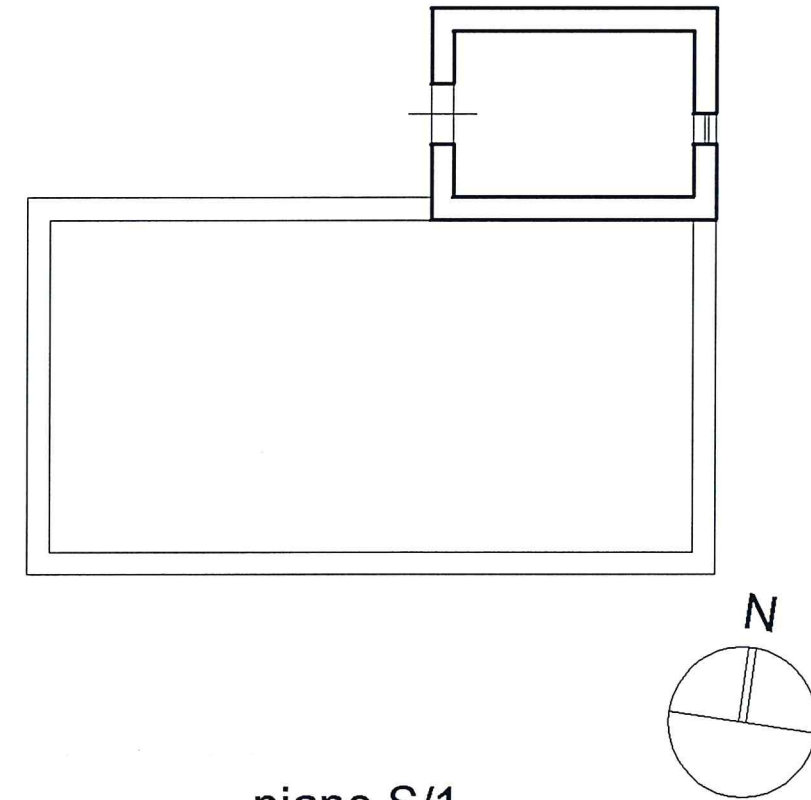

piano terra



piano S/1

